



# ORGANIZATIONAL CHART 2023-2024

Dr. Devon Q. Horton, Superintendent



Information contained within this document only summarizes the Organizational Structure for interested individuals. If there is a discrepancy between the information in this document and the current Organizational Structure, the documents obtained in the Superintendent's Office will always govern. The DeKalb County School District reserves the right to modify, alter or discontinue these reference materials for any reason.

# Superintendent's Office

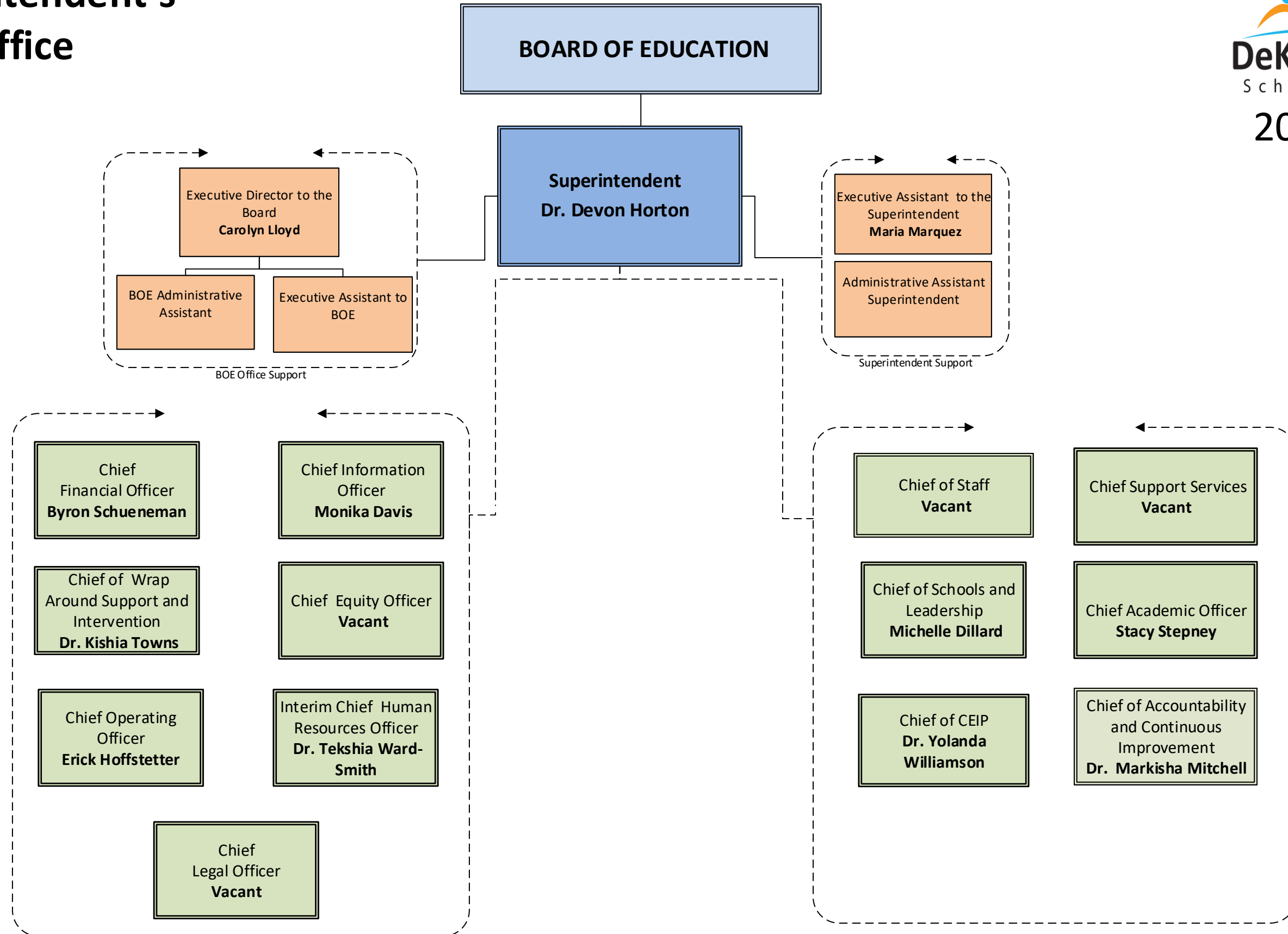

# Chief of Staff Office



2023-2024

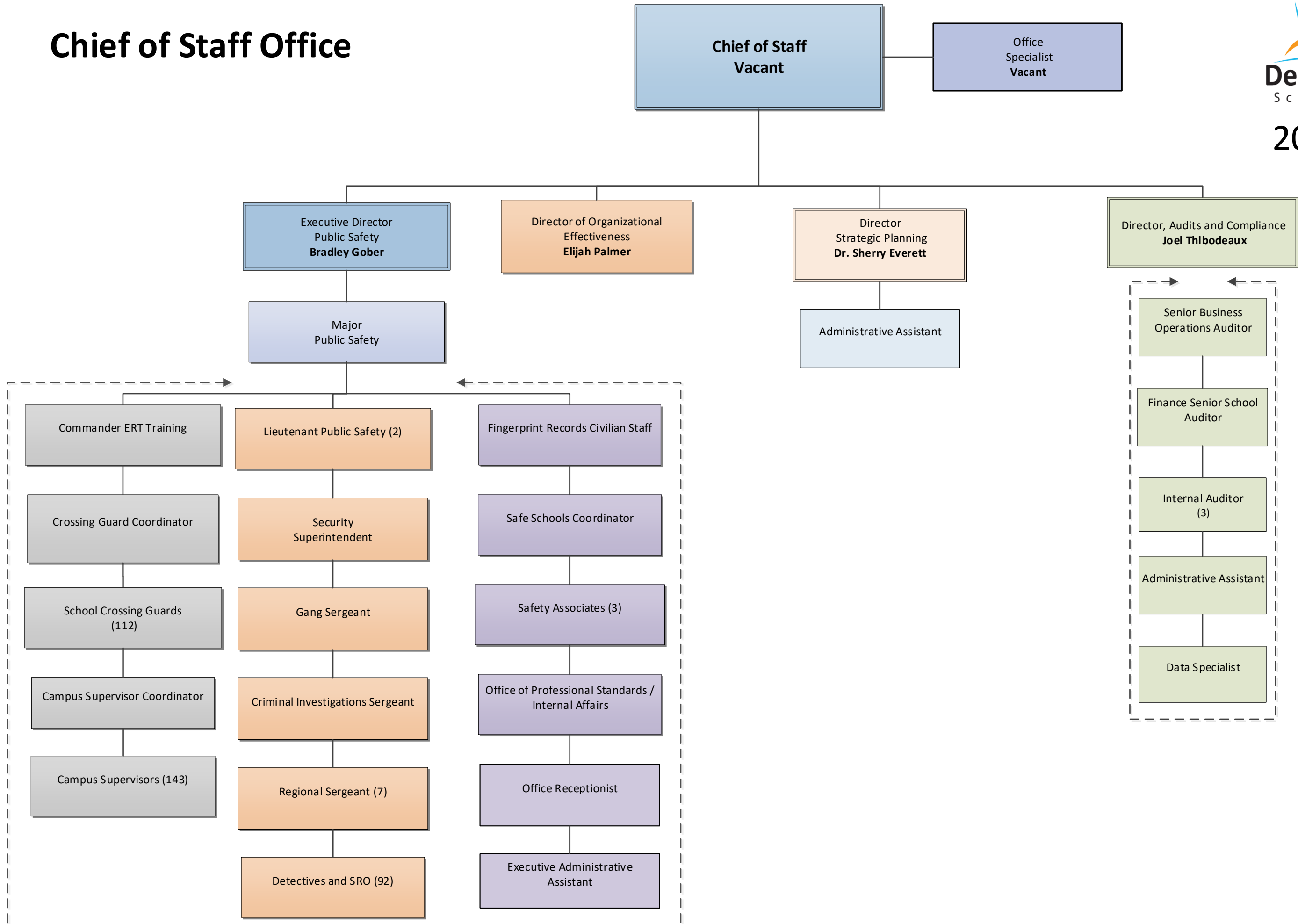

# Office of Accountability and Continuous Improvement

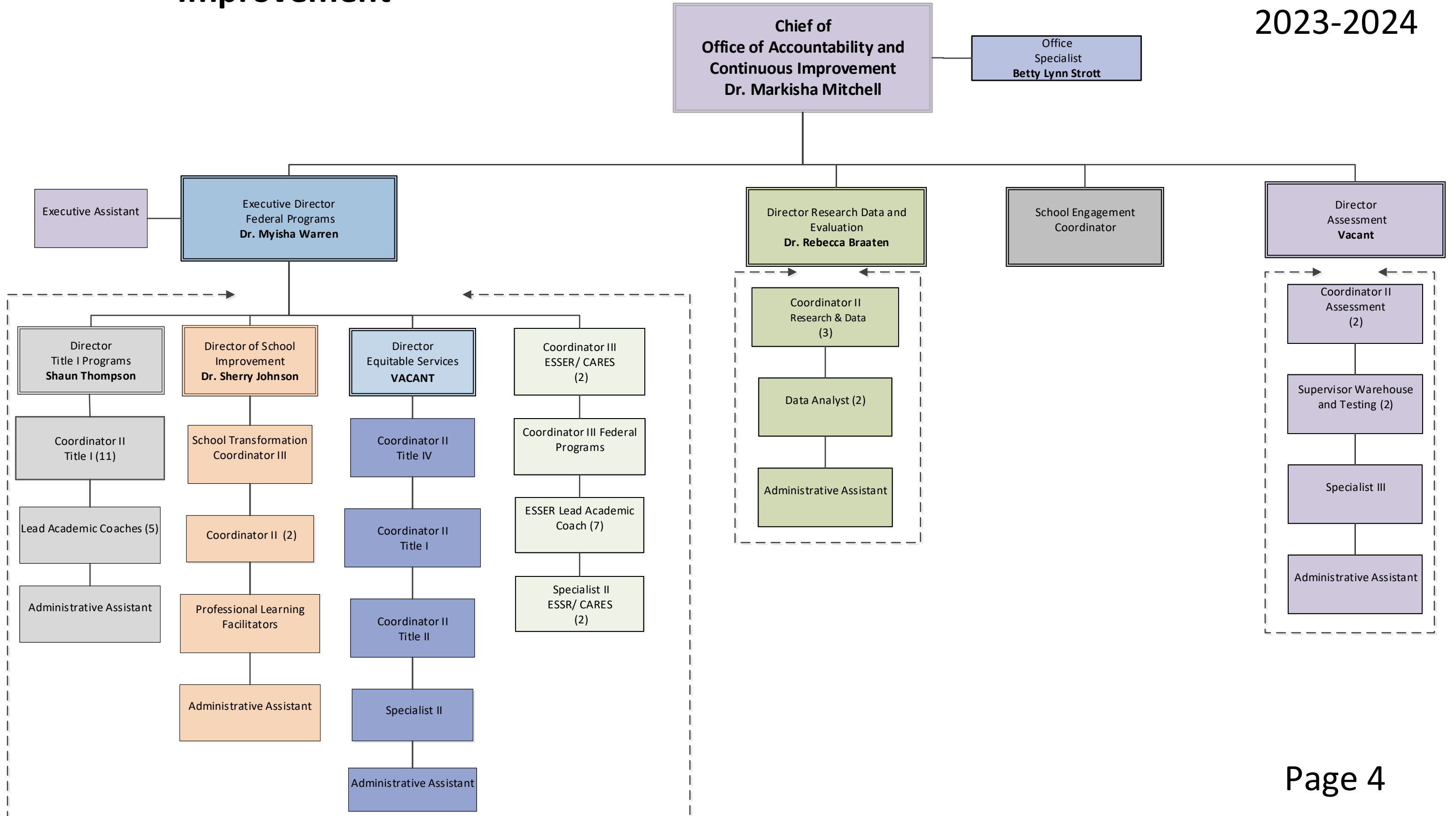

# Division of Community Empowerment, Innovation, and Partnerships



2023-2024

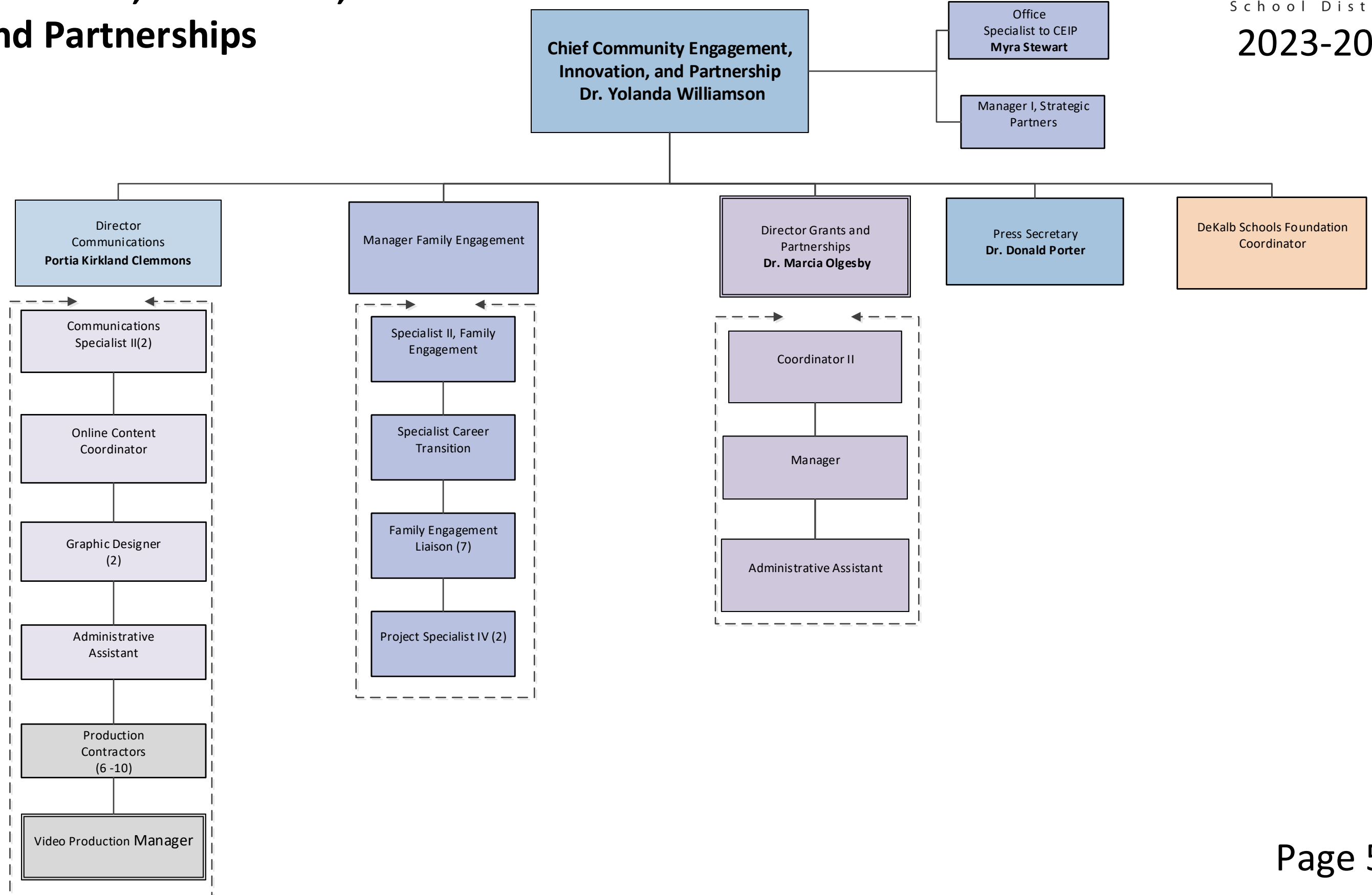

# Division of Curriculum and Instruction

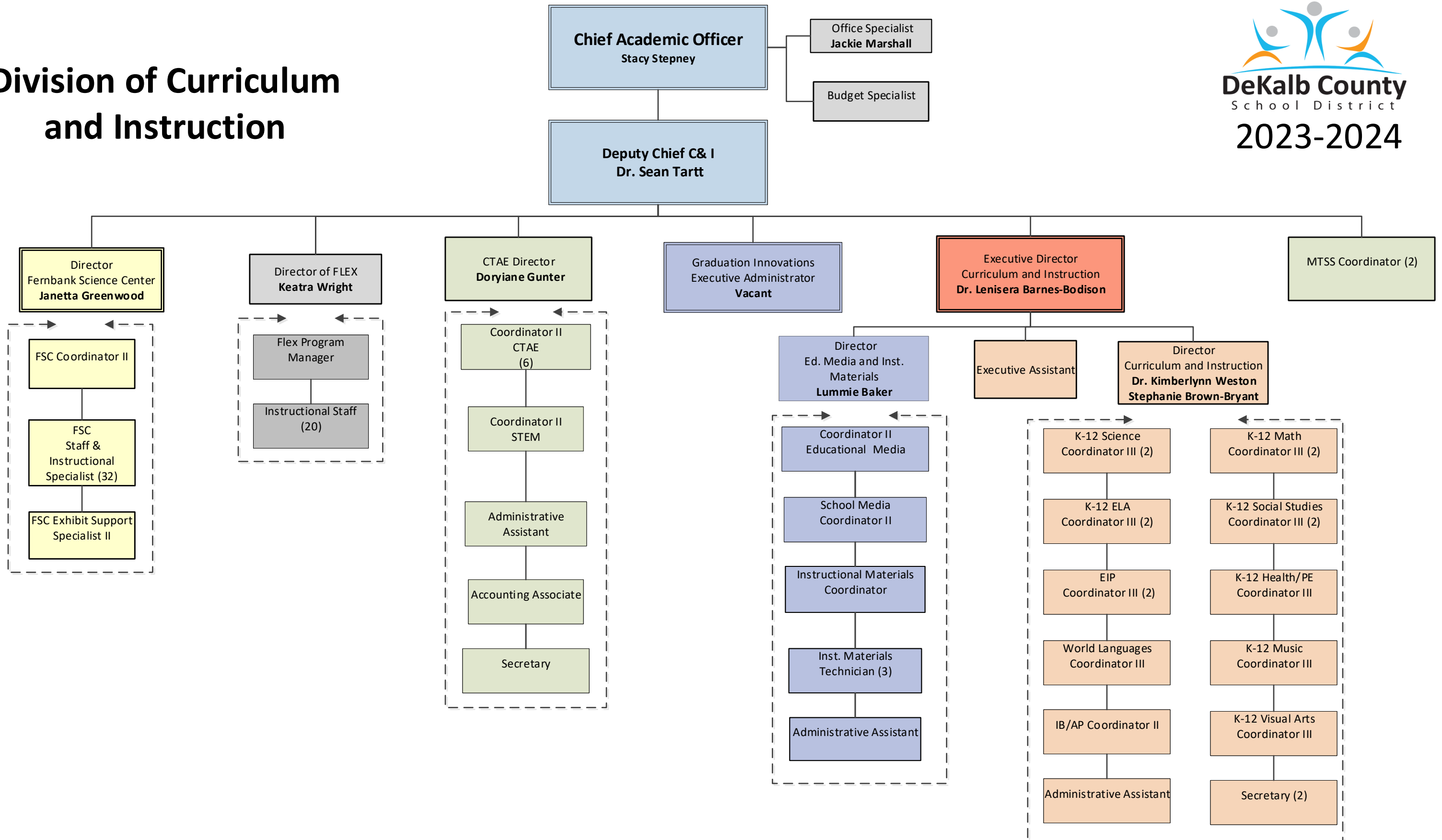

# Division of Equity

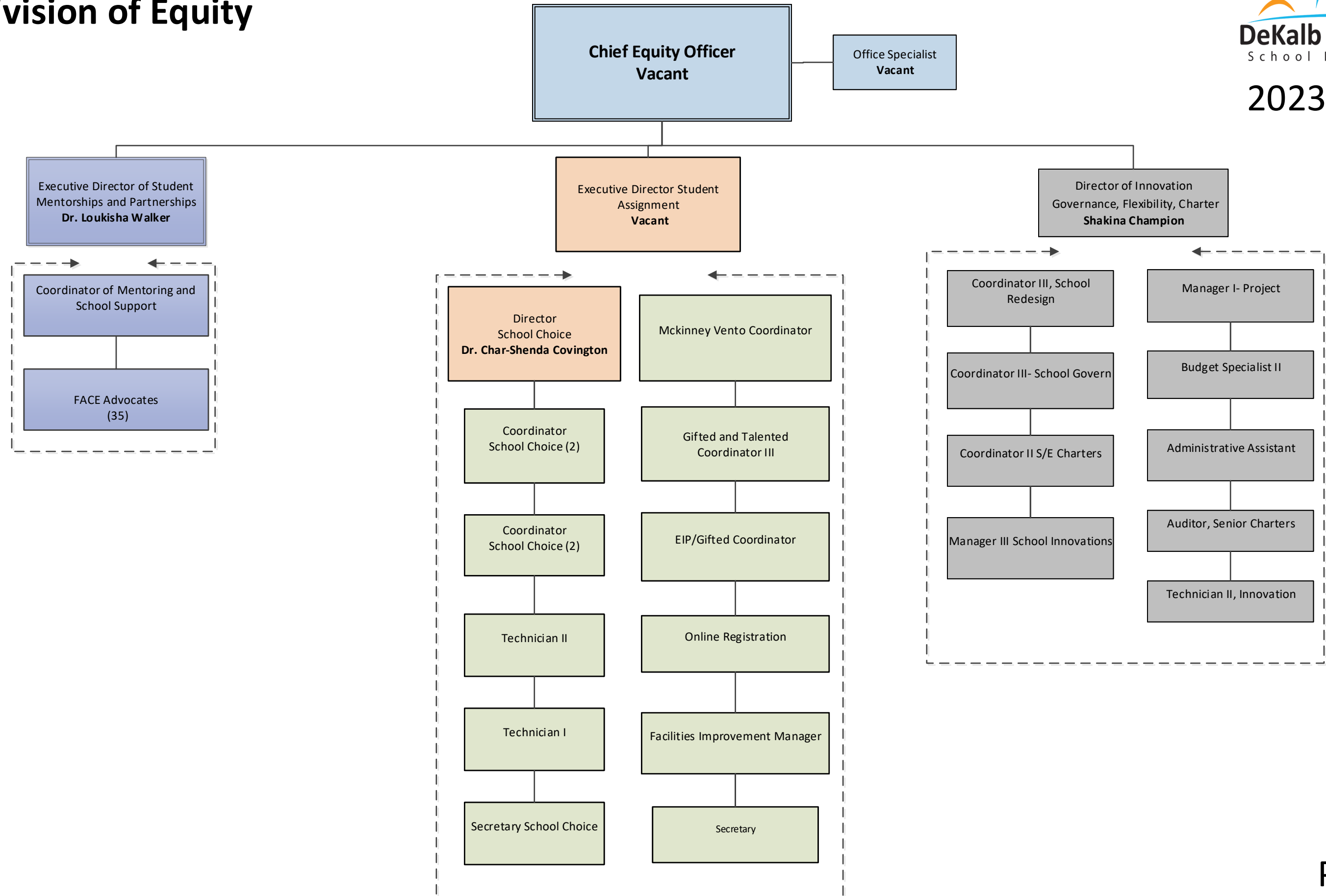

# Division of Finance

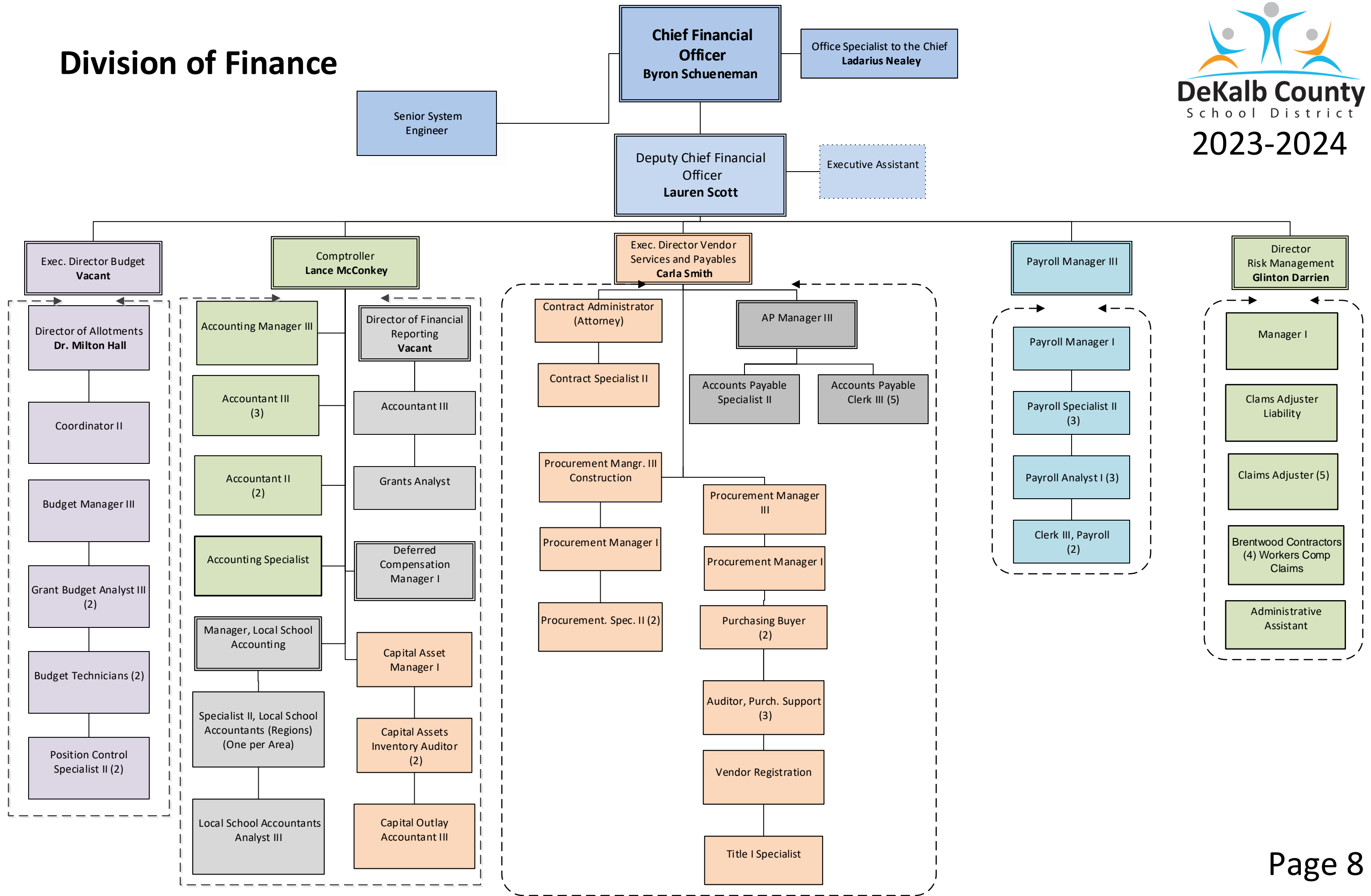

# Division of Human Resources



2023-2024

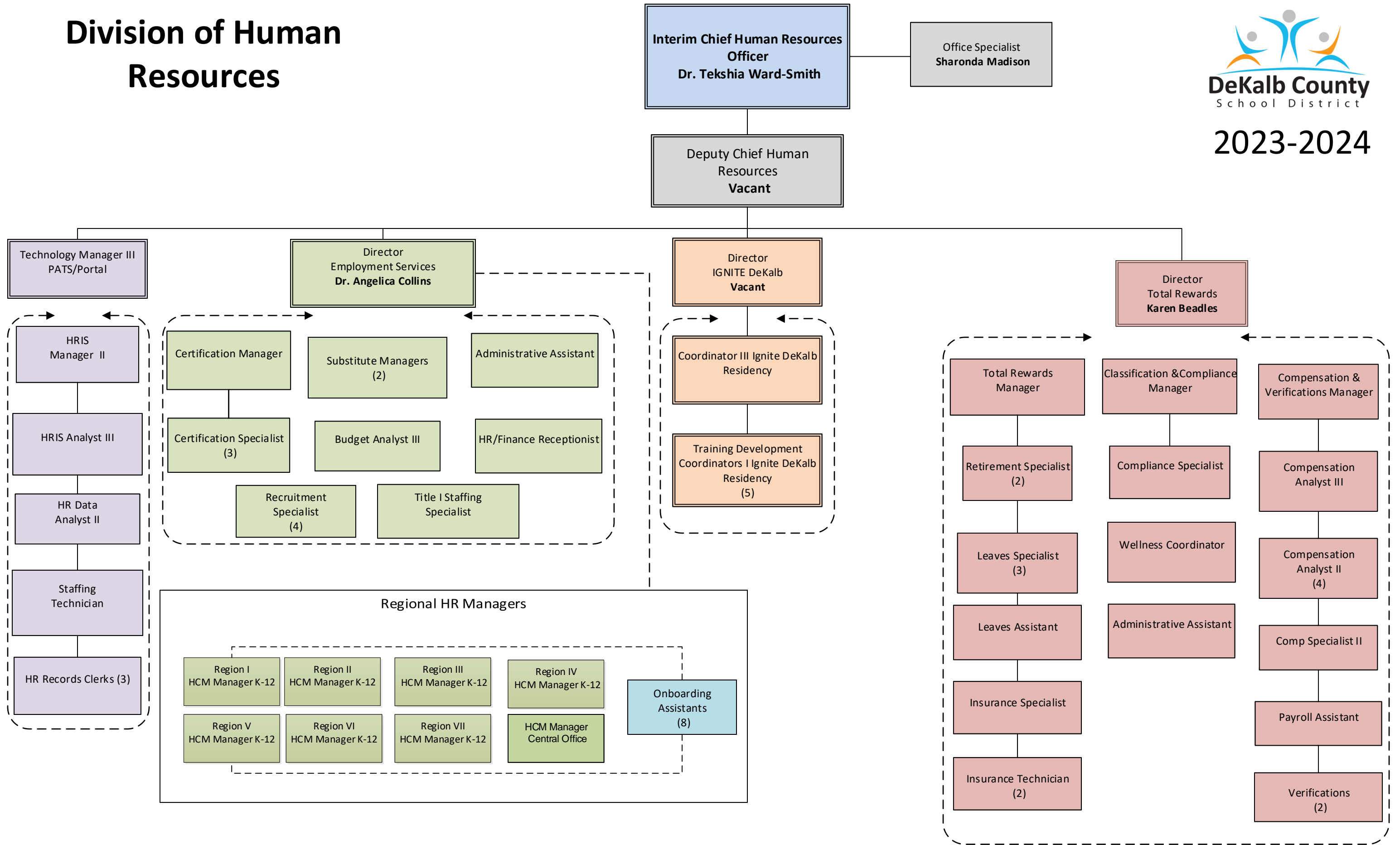

# Division of Information and Instructional Technology

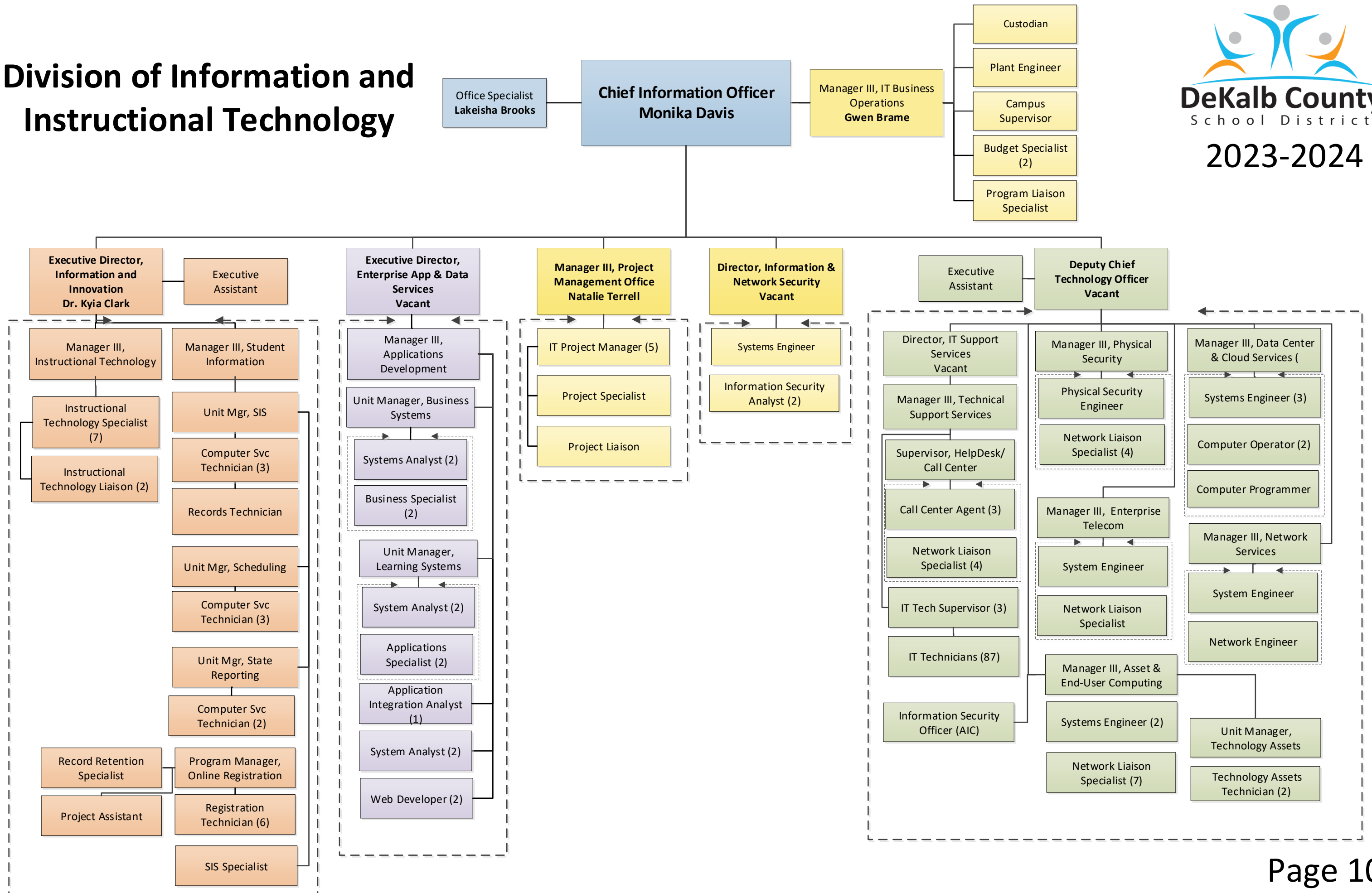

# Division of Legal Services

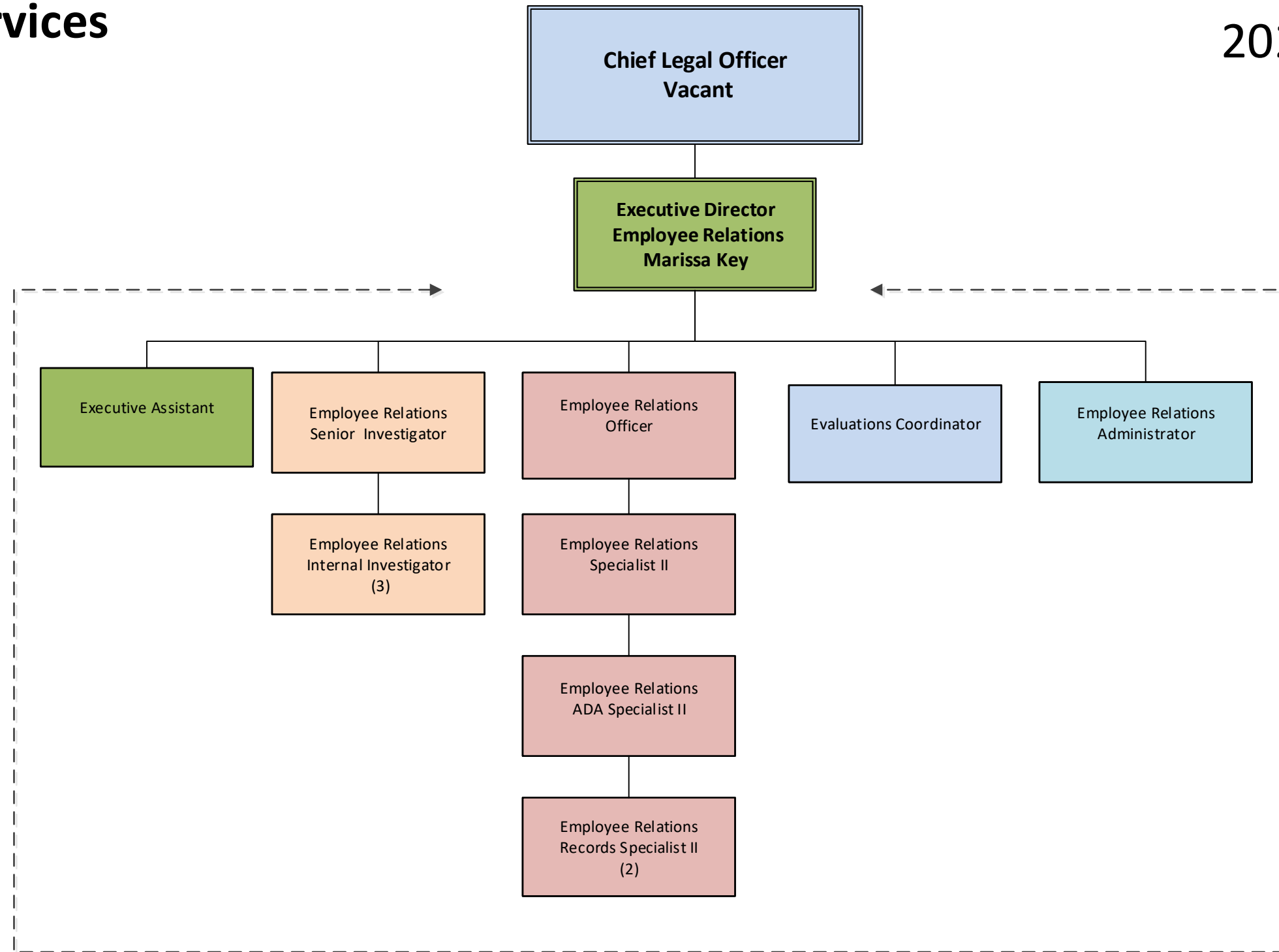

# Division of Operations Department of Facilities, Design & Construction, Planning and E-SPLOST Programming

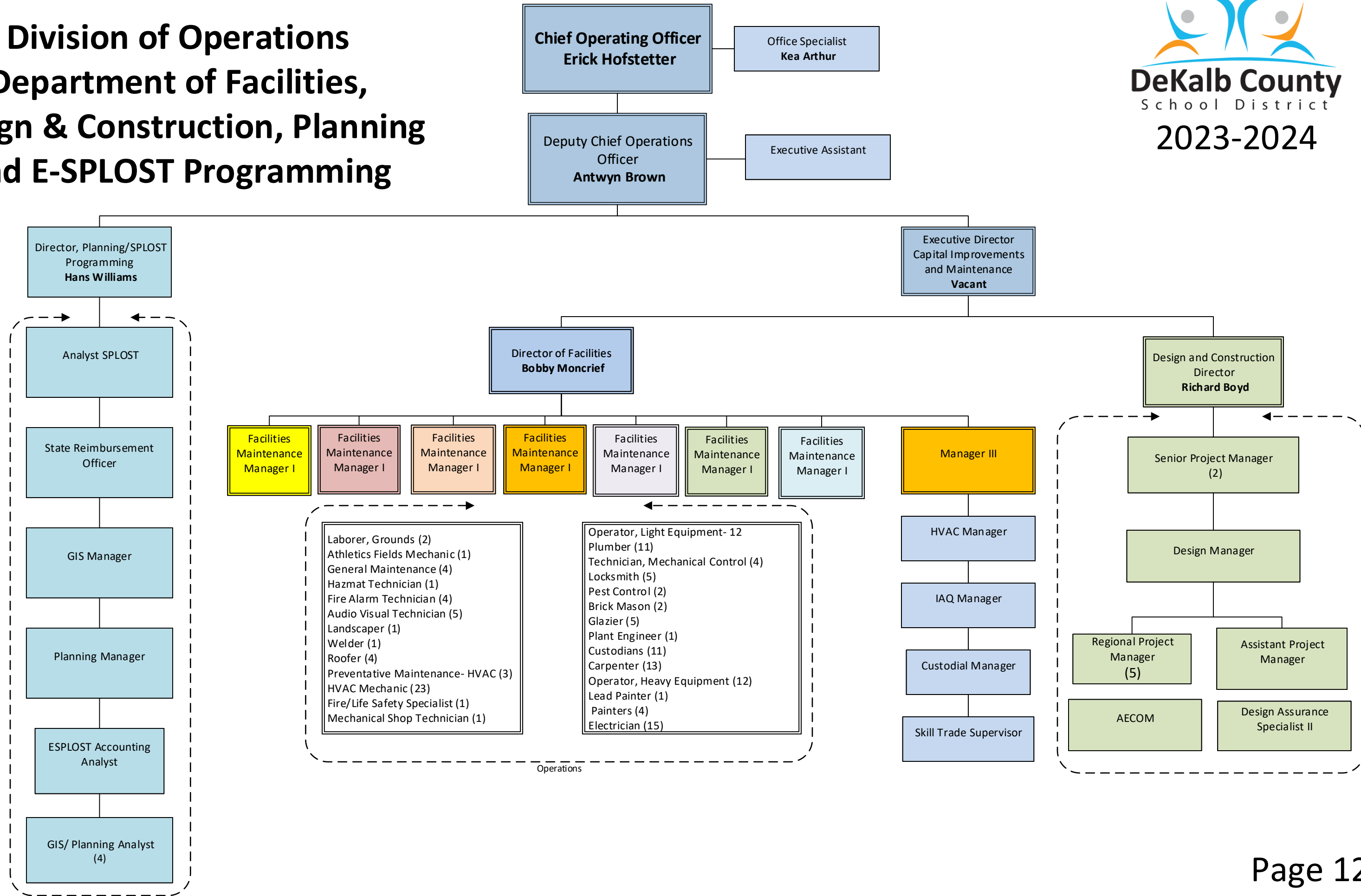

# Division of Operations Department of Transportation & Fleet Services



Chief Operating Officer  
Erick Hofstetter

Deputy Chief Operations  
Officer  
Antwyn Brown

Executive Director  
Transportation and Fleet  
Vacant

Director of Transportation Services  
Bernando Brown

Director Fleet Services  
Cedric Burse

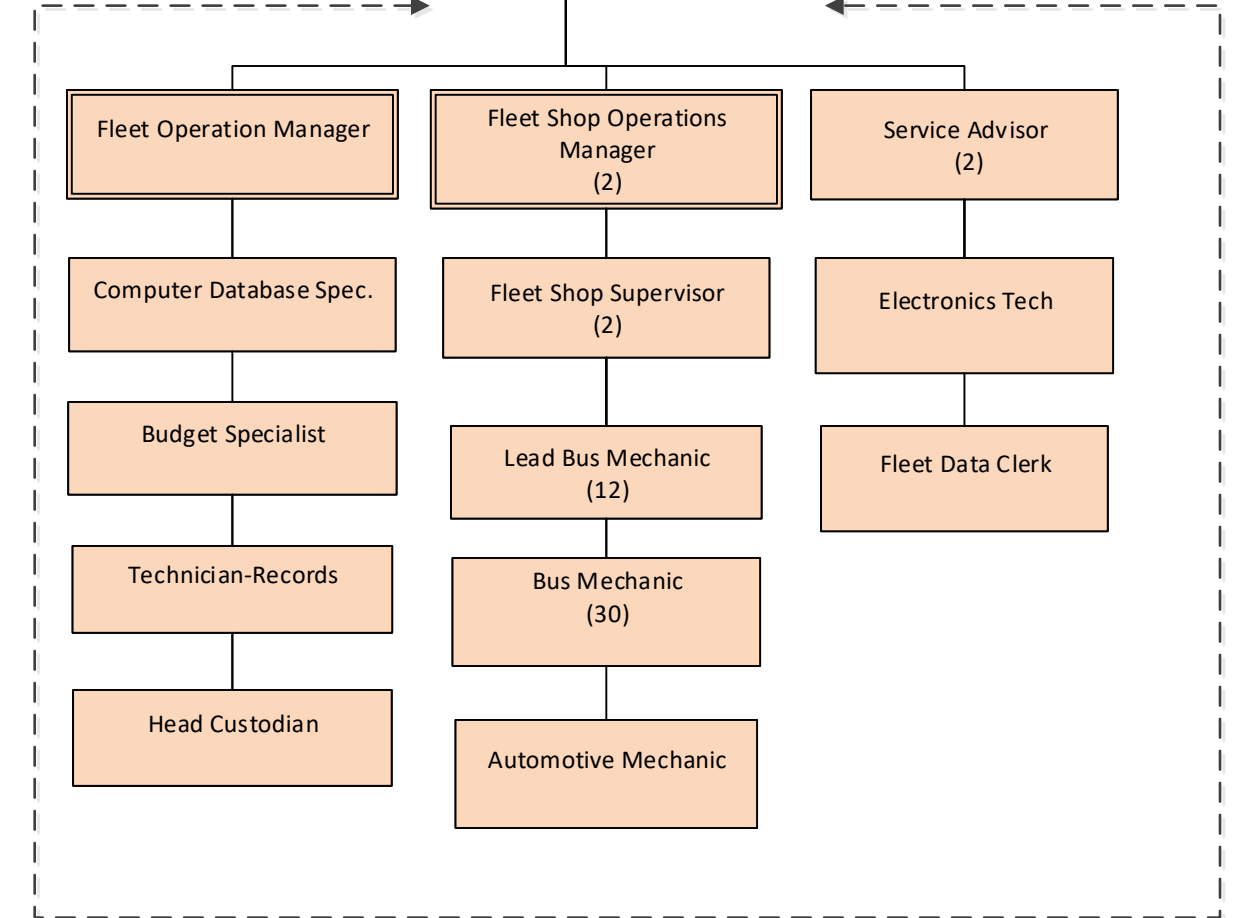
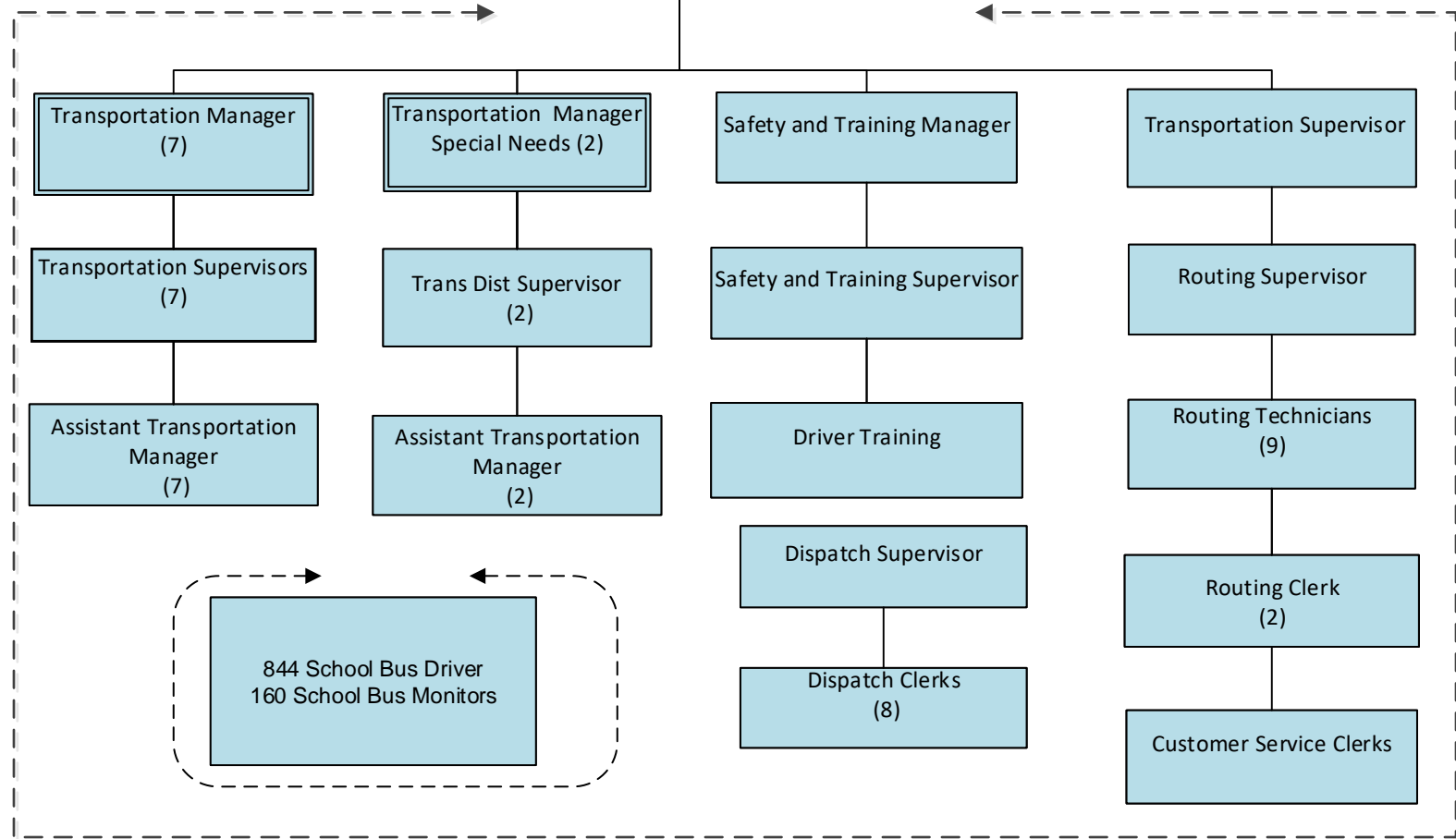

# Division of Operations Department of Business Services



2023-2024

Chief Operating Officer  
Erick Hofstetter

Deputy Chief Operations  
Officer  
Antwyn Borwn

Administrative Assistant

Director of Business Services  
Keith Singleton

Manager III Operations Employee  
Engagement

Manager II Board Management  
and Operations Communication

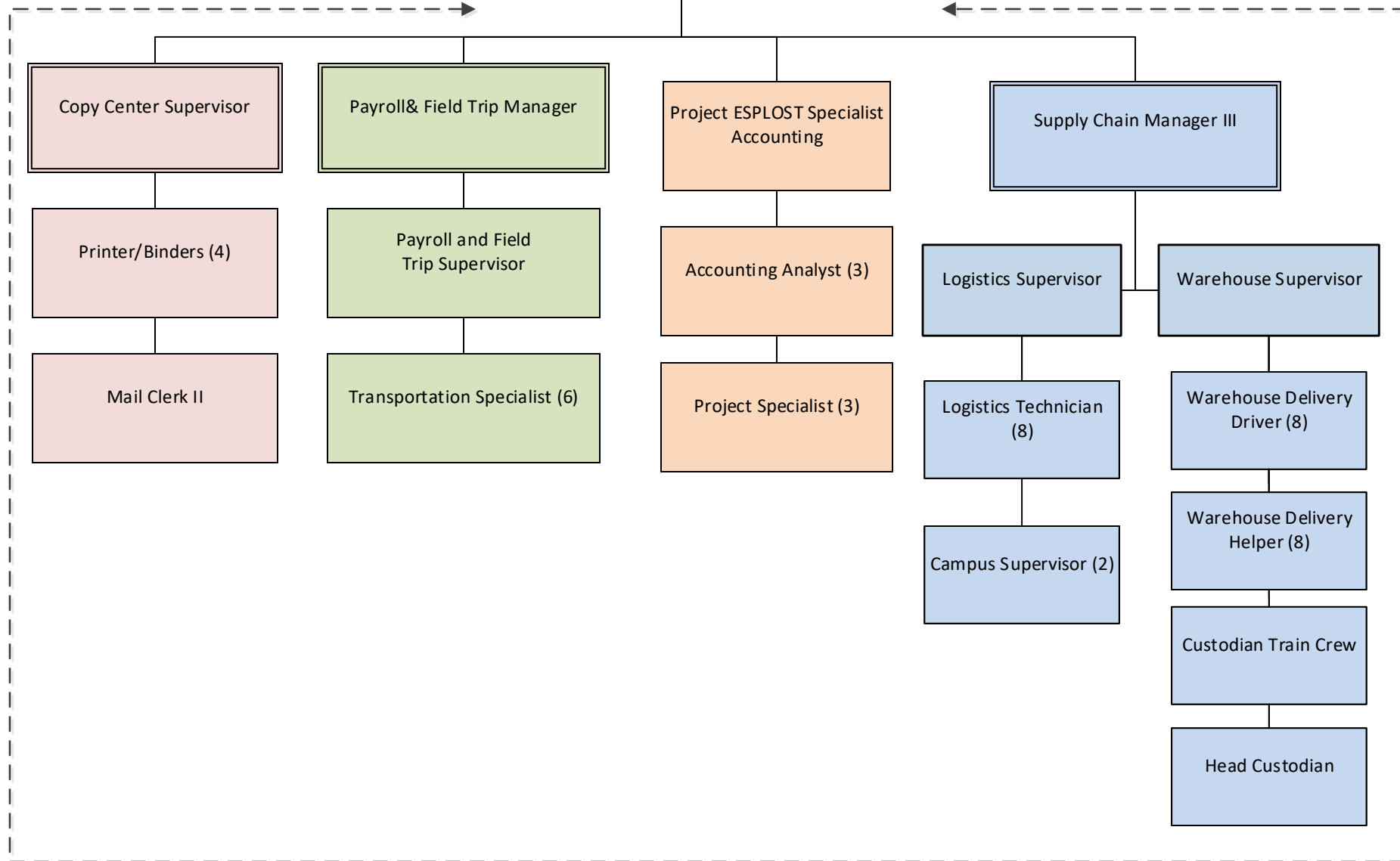

# Division of Operations Department of School Nutrition Services

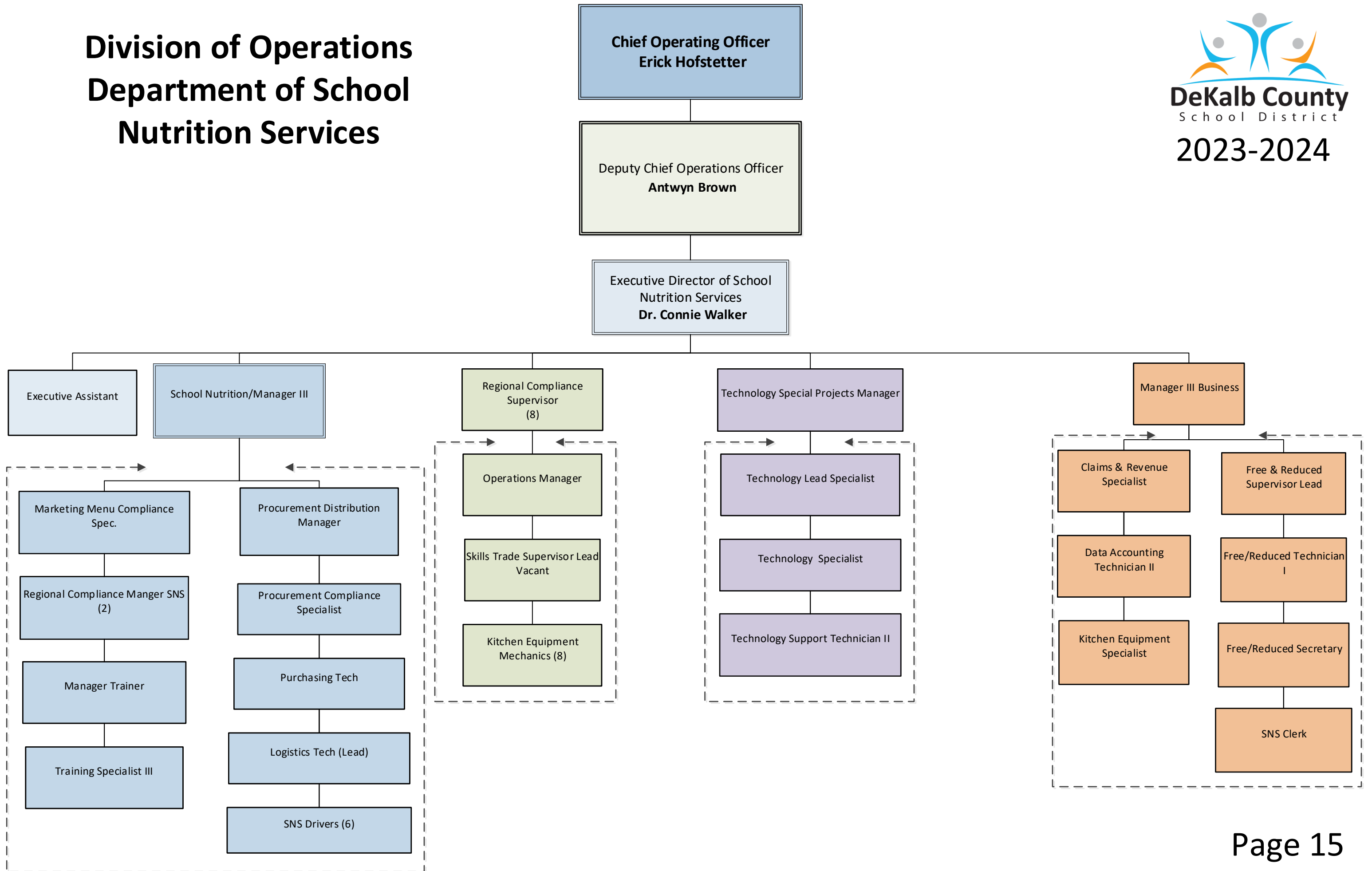

# Division of Schools and Leadership



**Chief of Schools and Leadership**  
**Michelle Dillard**

Office Specialist  
**Lakesha Smith-Warner**

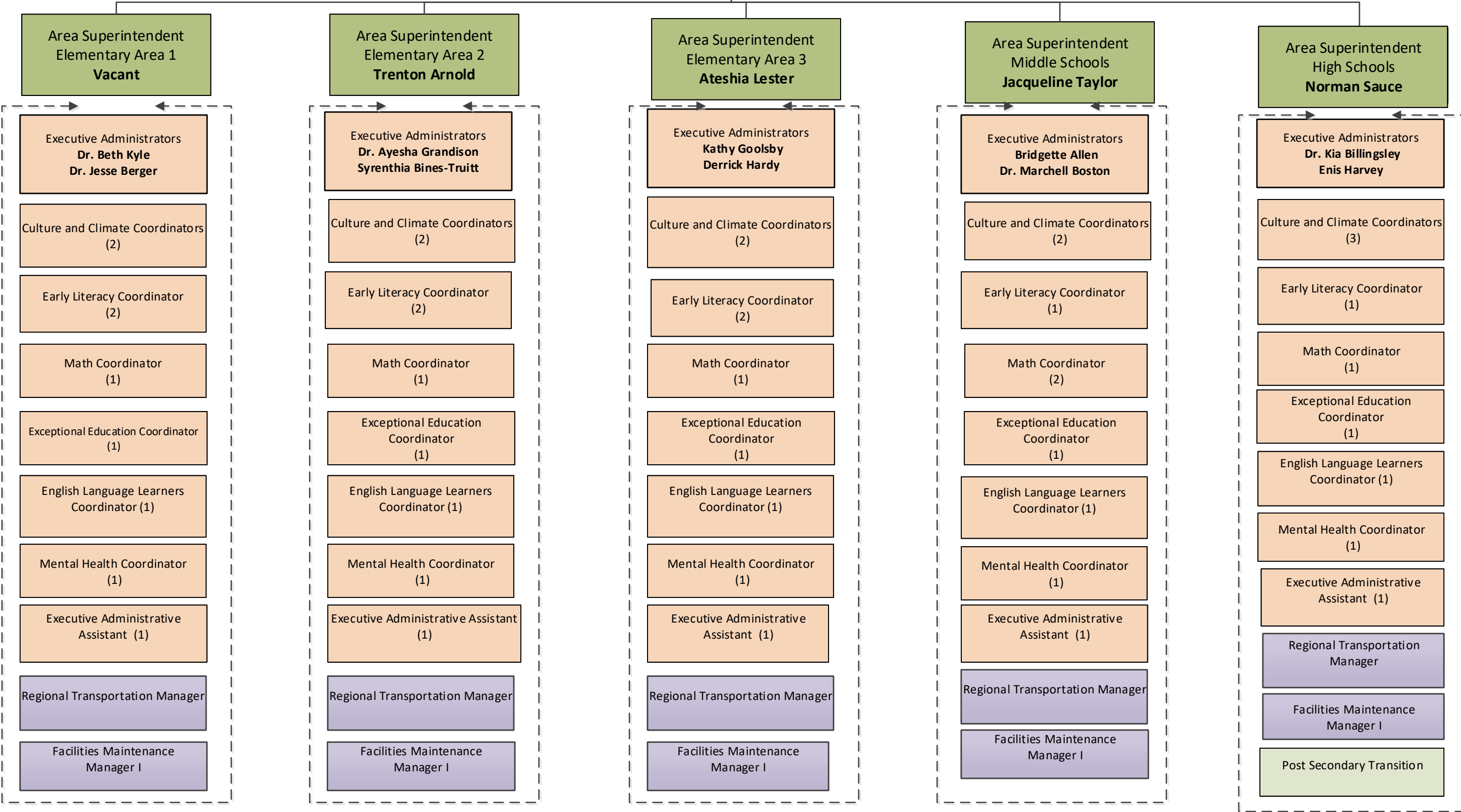

# Division of Schools and Leadership

Continued

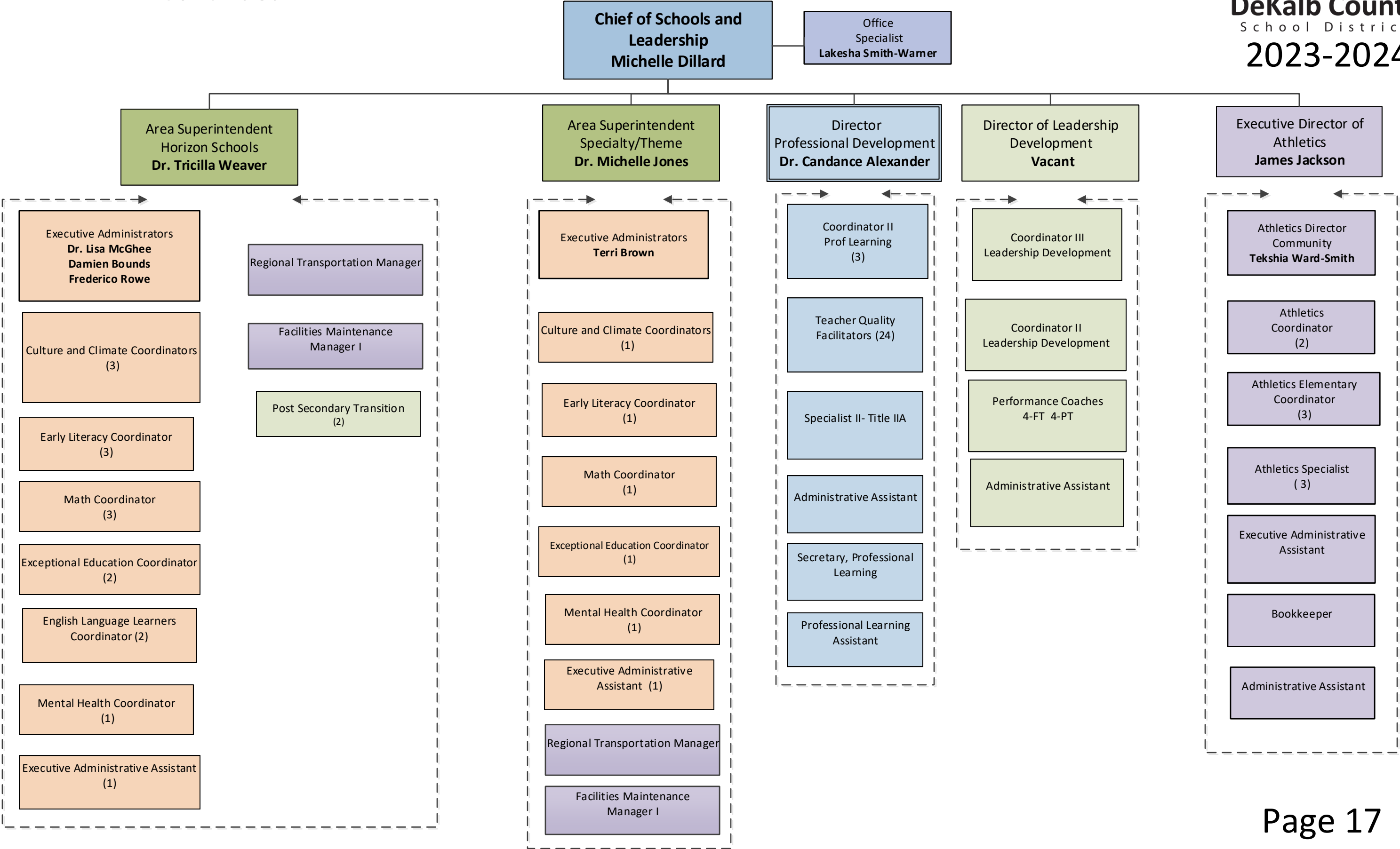

# Division of Student Services

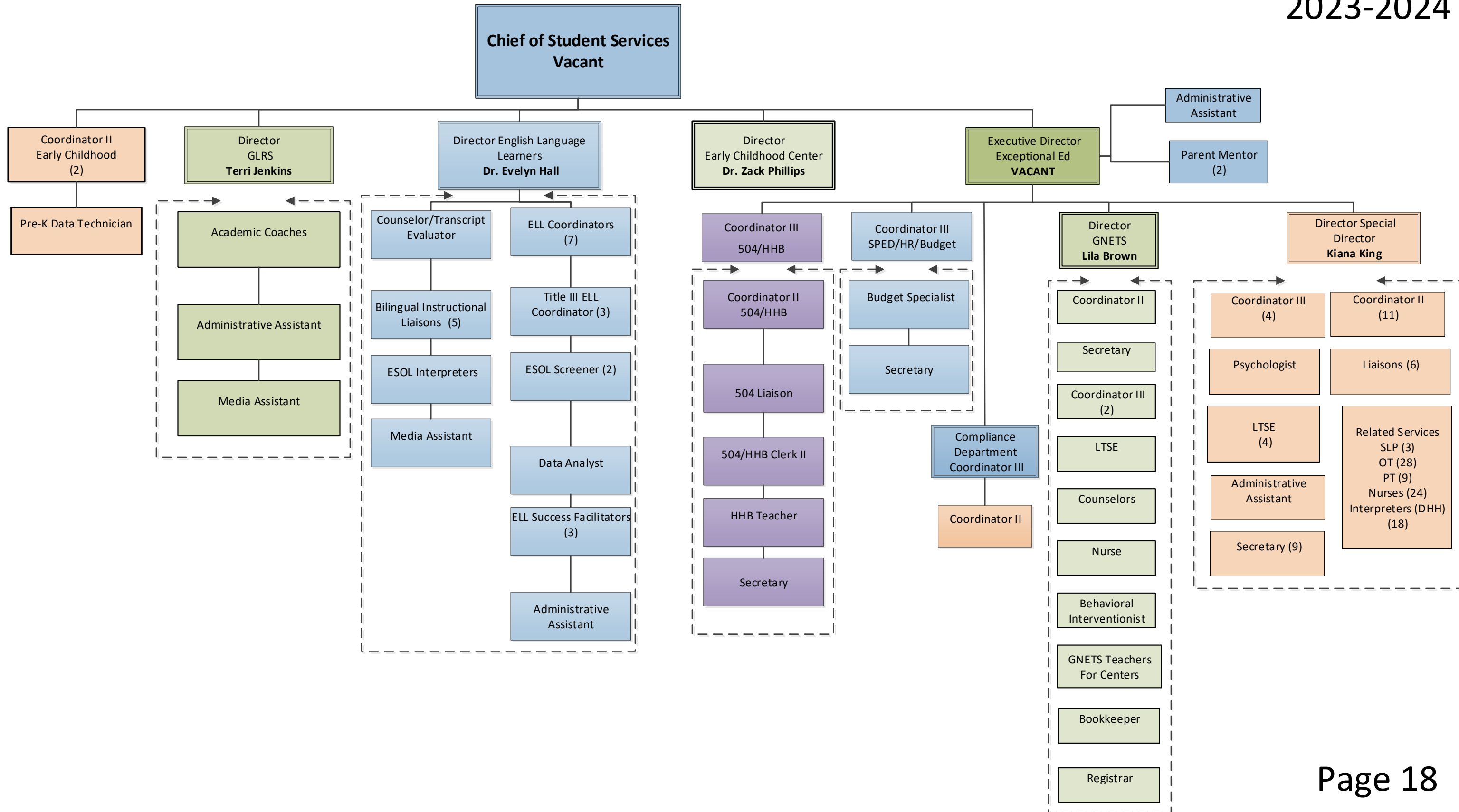

# Division Wrap Around Services

